

# STAINLESS STEEL 304 THREADED FITTINGS

## EQUAL SOCKET

COMPLY WITH BSEN1254-2:1998  
AS/NZS 4020:2018

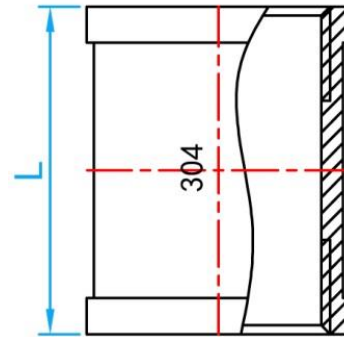

CROSS SECTIONAL VIEW

### DIMENSIONS

SKU	SIZE (inch)	L (mm)	WEIGHT (kg)	PCS/CTN
SS304ES015	½"BSPT	35	0.0555	500
SS304ES020	¾"BSPT	40	0.0752	300
SS304ES025	1"BSPT	44	0.1143	200
SS304ES035	1¼"BSPT	49	0.1825	100
SS304ES042	1½"BSPT	54	0.2316	50
SS304ES050	2"BSPT	62	0.3560	50
SS304ES065	2½"BSPT	71	0.5345	26
SS304ES080	3"BSPT	76	0.7950	12